

CATALOGUE DE LOCATION 2024

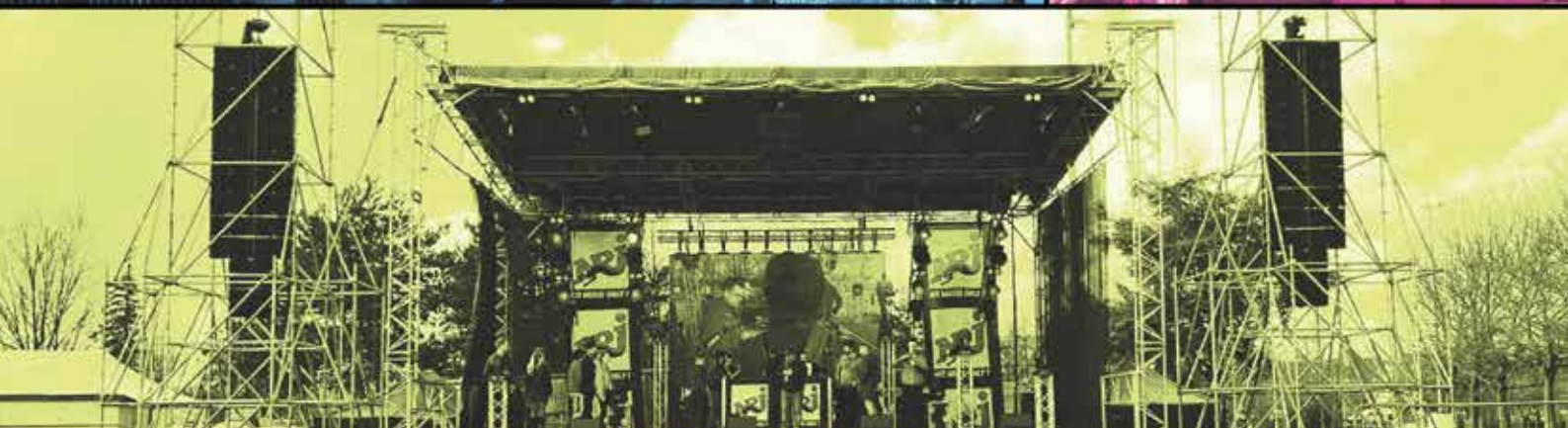

Qui sommes-nous ?

03

Nous trouver

05

Sonorisation

07

Eclairage

27

Effets spéciaux

40

46

Structures et scènes

61

Vidéo

68

Electricité

74

Décorations

81

Bornes photos

LE RÉFÉRENT TECHNIQUE DE VOTRE ÉVÉNEMENT

Depuis plus de 20 ans, WTECH Group est le partenaire technique événementiel pour la réalisation de vos projets.

Particulier ou professionnel, faites appel à nos services pour la location, la vente et l'installation de matériel de sonorisation, l'organisation de spectacles pyrotechniques, l'installation de scène de spectacle, l'éclairage et la mise en lumière de lieux, la projection vidéo et la captation d'événement, la réalisation et le montage de films.

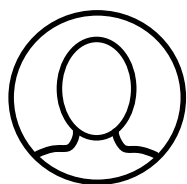

Un interlocuteur
unique pour
votre projet

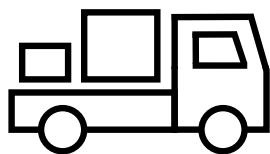

Transport &
installation du
matériel



100% de nos
clients satisfaits

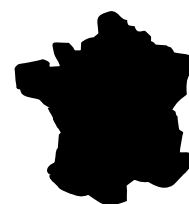

Intervention sur
toute la France

LABEL N°866



WTECH group est titulaire du label n° 866 des prestataires de service du spectacle vivant.

3

NOTRE SITE WEB

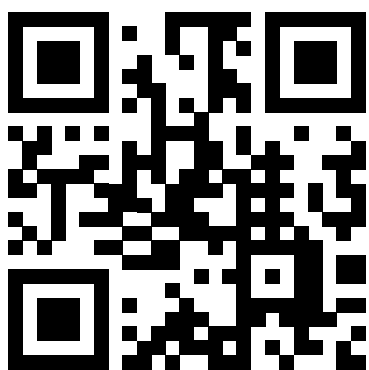

Retrouvez notre site web
en scannant ce QR code !

NOS RÉSEAUX



contact@wtech.fr



www.wtech.fr



WTECH group

4

NOUS TROUVER

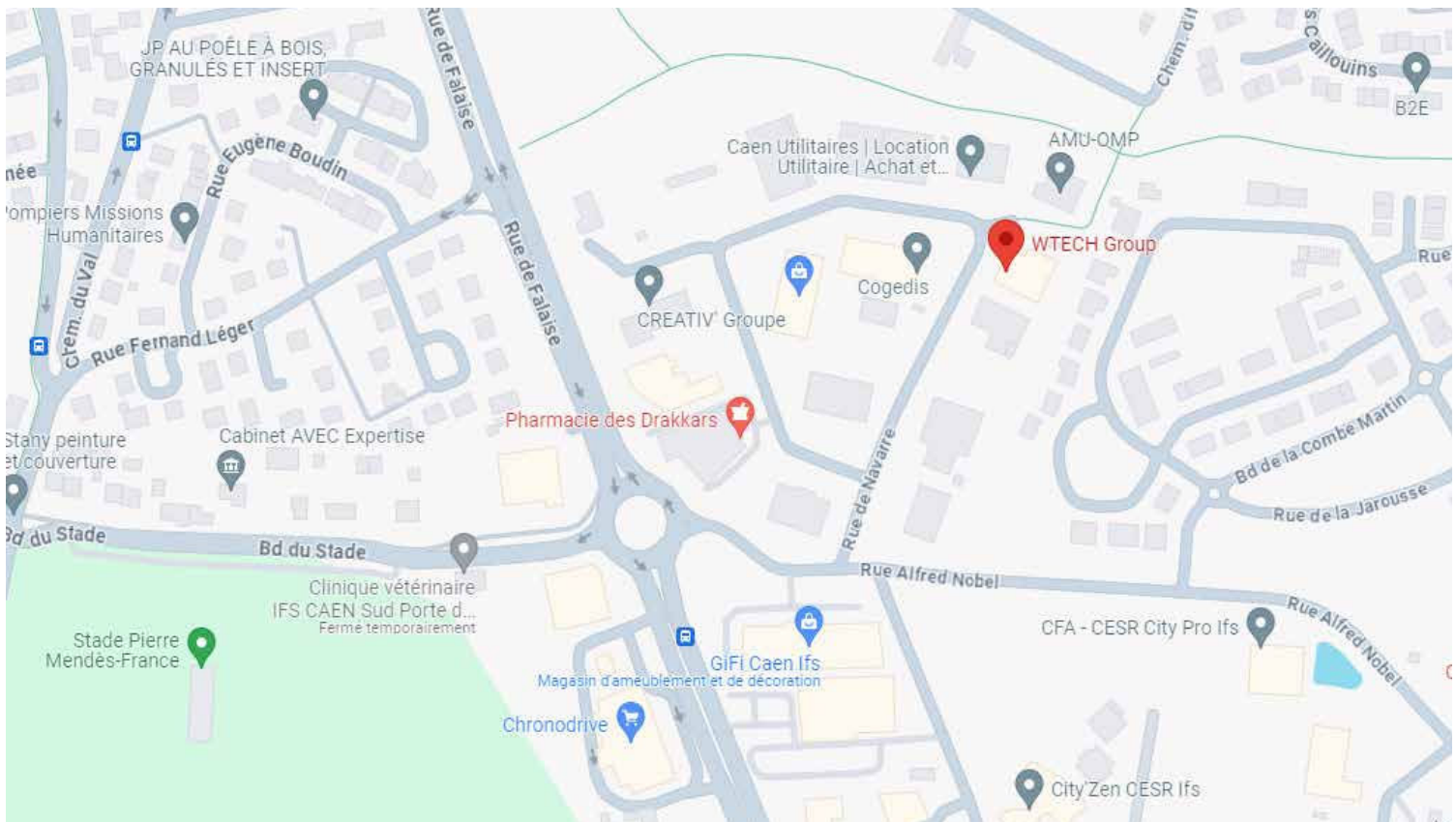

**25 RUE DE NAVARRE
14123 CORMELLES LE ROYAL**



5

25 rue de Navarre
14123 Cormelles le Royal



02 31 73 88 22

COEFFICIENT DE LOCATION

1	1.00
2	1.50
3	2.00
4	2.30
5	2.50
6	2.75
7	3.00
8	3.30
9	3.70
10	4.00
11	4.20
12	4.40
13	4.60
14	4.80
15	5.00

Notre grille, ci-dessus, vous permet de calculer le coût de location du matériel selon la durée totale d'utilisation que vous aurez prévue :

TARIF HT / JOUR x COEFFICIENT

Les coefficients sont dégressifs pour vous permettre d'exploiter le matériel dans les meilleures conditions tarifaires. Ainsi sur des périodes prolongées, vos coûts logistiques seront d'autant mieux amortis.

LES TARIFS SONT AFFICHÉS EN H.T

6

A person is seen from the side, operating a large, complex professional audio mixing console in a recording studio. The console is filled with numerous knobs, sliders, and buttons. The person's hands are positioned on the console, suggesting they are adjusting settings. The background is dark, with some blurred lights, emphasizing the focus on the mixing console and the operator. A semi-transparent green banner is overlaid across the middle of the image, containing the text "SONORISATION" in white, bold, uppercase letters.

SONORISATION



KARA II **UPGRADED**

Enceinte active type line array
2 voies 8"

55€/jour



BUMP + MBAR

Bumper accroche pour
Kara et SB18

50€/jour



SB18

Subwoofer de 18"
Accroche compatible avec Kara

40€/jour

LA8

Amplificateur LA8
4 x 2000W sous 8 ohms

100€/jour



LA4X

Amplificateur LA4X
4 x 1000W à 8 ohms

85€/jour



X8
Enceinte passive
2 voies 8"

25€/jour



X12
Enceinte passive
2 voies 12"

30€/jour



MTD 112
Enceinte passive
2 voies 12"

25€/jour



115XT
Enceinte active
2 voies 15"

35€/jour

ARC
Enceinte à courbure
constante active
2 voies 15"

55€/jour

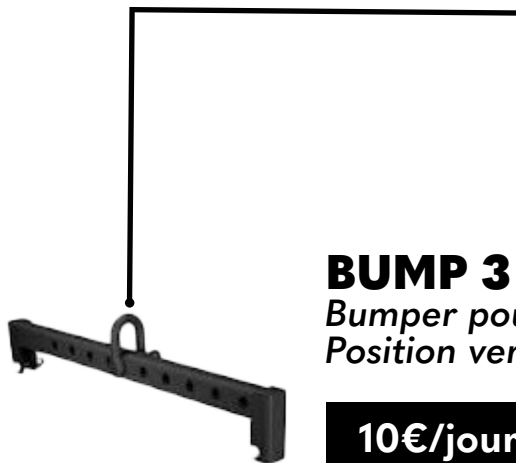

BUMP 3
Bumper pour ARCS
Position verticale

10€/jour





PS15
Enceinte passive de 15"

30€/jour



SATOC 16
Enceinte passive
8"

15€/jour



S6
Enceinte passive
6,5"

10€/jour



CM15
Enceinte passive
15"

20€/jour



BOSE 802
Enceinte passive
8x8"

25€/jour

ENCEINTES ACTIVES

audiophony



MT SUB 12A
Subwoofer amplifié de 12"

30€/jour



NOVA 10
Enceinte amplifiée de 10"

25€/jour



NOVA 12
Enceinte amplifiée de 12"

30€/jour

SUPPORTS D'ENCEINTES



Pied crémallière

15€/jour



Pied droit

10€/jour



Pied standard

5€/jour



Bar liaison

5€/jour

Support d'inclinaison

5€/jour



11



Support T double

5€/jour

Support totem

5€/jour



AMPLIFICATEURS



DIGAM 7000 Amplificateur 2 x 3500W

60€/jour



PLX 2402 Amplificateur 2 x 825W

20€/jour

PLX 3200 Amplificateur 2 x 1050W

25€/jour

LIGNE 100V



MP26G APART Projecteur de son ligne 100V 26W

8€/jour



PC 3301 Amplificateur 2 x 700W

35€/jour

12



PG48
Micro voix
cardioïde

4€/jour



SM57
Micro instrument
dynamique cardioïde

5€/jour



SM58
Micro voix
dynamique cardioïde

5€/jour



BETA57a
Micro voix
dynamique supercardioïde

7€/jour



BETA91a
Microphone statique
directivité héli-cardioïde

7€/jour



BETA58a
Micro voix
dynamique supercardioïde

7€/jour



BETA52
Micro instrument
dynamique supercardioïde

10€/jour



BETA87a
Micro voix
statique supercardioïde

15€/jour



BETA98
Micro statique
pour instrument

16€/jour

**E901***Micro grosse caisse
cardioïde***15€/jour****E604***Micro TOMS
dynamique cardioïde***6€/jour****E840***Micro voix
dynamique cardioïde***5€/jour****MD421***Micro
dynamique cardioïde***12€/jour****E835S***Micro voix
dynamique cardioïde***4€/jour****E614***Micro statique
supercardioïde***9€/jour****E906***Micro dynamique
supercardioïde***8€/jour****E935***Micro voix
dynamique cardioïde***8€/jour****E904***Micro TOMS
dynamique cardioïde***8€/jour****E908***Micro cardioïde
pour instrument***16€/jour****14**

MICROS



C414
Micro omni
cardioïde

31€/jour



C451
Micro statique
cardioïde

12€/jour



D112
Micro
grosse caisse

10€/jour



C535
Micro statique
cardioïde

15€/jour

MICROS



DPA 4061
Micro miniature omni

35€/jour

DPA 4488
Micro casque cardioïde

35€/jour



DPA 4099
Micro D-VOTE

35€/jour

DPA 4066
Micro casque omni

35€/jour



MICROS



KM184
Micro statique
cardioïde

18€/jour

D6
Micro
grosse caisse

20€/jour



15

PIEDS POUR MICRO



Petit pied

4€/jour



Pied droit

5€/jour



Grand pied

5€/jour

BOITE DE DIRECT ACTIVE



BEHRINGER DI100

Boîtier de direct

5€/jour

BSS AR133

Boîtier de direct

7€/jour



LIAISON EAR MONITOR

SHURE



EW300 IEM

35€/jour



PSM900

90€/jour



PSM1000

120€/jour

16

LIAISONS HF



EW100 G2
Récepteur simple
micro main type e835

35€/jour



EW300 G2
Récepteur simple
micro main type e835

40€/jour



GLDX
Récepteur simple
micro main type sm58 (batterie)

25€/jour



UR4S+
Récepteur simple
micro main UR2 ou récepteur UR1

80€/jour



EW100 G4 1G8
Récepteur simple numérique
micro main type e835S

40€/jour

EMETTEURS



UR1
Emetteur pocket

25€/jour



UR2
Emetteur main
avec capsule interchangeable

25€/jour



SK100
Emetteur pocket

10€/jour

17

AXIENT® DIGITAL

High Density Mode



AD1
Boitier ceinture
Axient Digital

40€/jour



AD2
Micro main
Axient Digital

40€/jour



AD4D
Récepteur double
Axient Digital

100€/jour

WAVENET TENG42
Émetteur / récepteur / antenne inclus

350€/jour



18



A2008

Antenne passive directive

25€/jour



AD 1800 1G8

Antenne active/directive numérique

20€/jour



A1031 U

Antenne passive omni

15€/jour



UA874

Antenne active/directive

28€/jour





X32
Console
32 entrées / 16 sorties

150€/jour



TF1
Console
16 entrées / 16 sorties

80€/jour



SQ5
Console
16 entrées / 16 sorties

150€/jour



SQ7
Console
32 entrées / 16 sorties

180€/jour





M7CL

Console 32 entrées / 16 sorties

300€/jour



CL5

Console 72 entrées / 32 sorties

350€/jour

MIXAGE ANALOGIQUE

JBSYSTEMS

YAMAHA



MIX 5,2 USB

Console
4 entrées / 2 sorties

17€/jour



MG 16fx

Console
16 entrées / 4 sorties

30€/jour



EMX640

Console 6 entrées / 4 sorties
Amplificateur 2 x 300W

50€/jour

PROCESSEURS

xta

NEXO

BOSE



802C BOSE

Contrôleur analogique
pour Bose802

20€/jour



DP6i XTA

Contrôleur numérique 2in / 6 out
avec logiciel AudioCore

30€/jour



PS15 TD V1 NEXO

Contrôleur analogique
pour ps15

20€/jour

NEW



CDJ3000

150€/jour



CDJ2000 NX2

120€/jour

NEW



DJMA9

120€/jour



SL1210 MK3

50€/jour

DJM900 NX2

120€/jour





DX168
16 entrées / 8 sorties

70€/jour



S16
16 entrées / 8 sorties

40€/jour

RIO D2 3224
32 entrées / 24 sorties

150€/jour



GAMME WTECH GROUP



MULTI FOH
4 x RJ45 / 2 x PowerCon

55€/jour

RACK FOH
2 switch SG310
PC LA-network + Dante contrôleur
+ Smart / carte son / onduleur

140€/jour



RACK STAGE
2 switch SG310 / Alim 63A vers 2 x 32A
Splitter AES / onduleur

80€/jour

INTERPHONIE



CENTRALE INTERCOM

30€/jour



BOITIER + CASQUE

12€/jour

CABLAGE



MODULE

1m	1€/jour
2m	1€/jour
3m	1€/jour
5m	2€/jour
10m	2€/jour
15m	2€/jour
20m	3€/jour
25m	3€/jour
50m	4€/jour
100m	5€/jour

RJ45

0.50m	1€/jour
1m	2€/jour
2m	3€/jour
3m	3€/jour
5m	5€/jour
10m	10€/jour
15m	12€/jour
30m	20€/jour
50m	30€/jour
75m	40€/jour



Livré sur enrouleur



Livré sur enrouleur



KIT 2 FOUETS RJ45/XLR 4 x XLR 3p

10€/jour

24



TRAVERSÉE 32A TETRA
1 alim tetra 32A / 2 câbles RJ45

5m	6€/jour
15m	10€/jour
25m	15€/jour



TRAVERSÉE 32A MONO
1 alim mono 32A / 2 câbles RJ45

5m	6€/jour
15m	8€/jour

MULTIPAIRES



MULTI 8
8 paires XLR

10m	8€/jour
15m	10€/jour
45m	20€/jour



MULTI 12
12 paires XLR

10m	10€/jour
15m	15€/jour
20m	20€/jour



MULTI 16/4
16/4 paires XLR - 40m
Option : fouet retour

30€/jour



MULTI 32/8
32 paires XLR + driver 8 paires XLR - 50m
Option : fouet retour

50€/jour

25

CABLAGE

XLR BOSE

10m	1€/jour
25m	3€/jour

HP 2P

3m	1€/jour
5m	1€/jour
10m	1€/jour
15m	2€/jour
20m	2€/jour
25m	3€/jour

HP 4P

3m	2€/jour
5m	2€/jour
10m	2€/jour
15m	3€/jour
25m	4€/jour

HP 8P

10m	3€/jour
15m	4€/jour
2 x 4P	3€/jour
4 x 2P	3€/jour

CA COM

NEW

DO 10	10€/jour
DO 25	15€/jour
DO FIL	5€/jour
DO SUB	5€/jour

4P => 2 x 2P

10m	2€/jour
15m	3€/jour

2 x 2P

10m	3€/jour
-----	---------

**Manchon/adaptateur/boitier
sur demande**

26



ÉCLAIRAGE



310H

Projecteur type PC 1000W

7€/jour



329HPC

Projecteur type PC 2000W

15€/jour



614S

Projecteur type découpe 1000W

21€/jour



714S

Projecteur type découpe 2000W

25€/jour



PAR 64

Projecteur type PAR 1000W

6€/jour



PAR 56 OCTO

Projecteur type PAR octogonal 300W

5€/jour



BARRE ACL

*2 barres de 4 PAR64
Avec lampe 250W / 28V ACL*

45€/jour



KORRIGAN

Projecteur type poursuite 1200W HMI

135€/jour



FL 1300

*Projecteur type BLINDER
2 x 650W*

12€/jour



BLINDER LED

*Projecteur type BLINDER
2 x 100W LED*

10€/jour



FL 2400

*Projecteur type BLINDER
4 x 650W*

25€/jour



CLAP 1000

*Projecteur type BLINDER
4 x 250W*

15€/jour

29



SUNSTRIP

Projecteur type rampe T10 10 x 75W

30€/jour



BT THEATRE 150EZ
Projecteur type PC 150W LED

30€/jour

GAMME VINTAGE



VINTAGE BLAZE 33

Projecteur type vintage 300W lampe RGBW (led)

45€/jour

30



NEW



W600 SMD

Projecteur flood / strobe 504 led smd 21 000 lumens
Ouverture 110°, IP65, wifi dmx, matricable sur 12 segments

80€/jour

NEW



ELP PAR

Projecteur PAR zoom LED 7 x 40W RGBW

35€/jour



IR LED

Projecteur PAR LED 18 x 3W RGBW

20€/jour

NEW



PIX BAR 400 G2

Bar LED IP65, 16 x 8W ouverture 25-42°

45€/jour



TOURKOLOR

Projecteur PAR IP65 180W RGBW

30€/jour

NEW



BT AKULITE IP

Projecteur LED sur batterie IP65 6 x 10W

30€/jour



MAC AURA XIP

*Lyre wash 420W LED RGBW IP55
Effet filament aura*

110€/jour

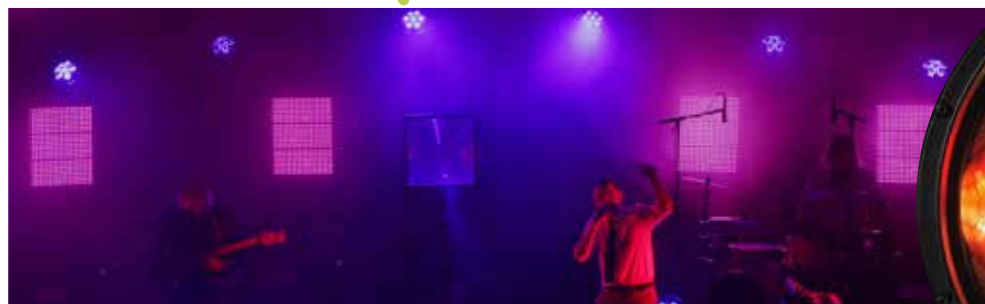

NEW

AZOR SP2

*Lyre 300W LED avec module couteau, zoom 3-50°
CMY, 1 roue de couleur, 1 roue de gobo, cto, 1 prism*

100€/jour

ERA300
*Lyre spot 260W LED, CMY 1 roue de couleur
2 roues de gobos, prism 5 facettes / iris*

80€/jour



32



SERVOCOLOR 4K

*Lyre wash
285W LED RGBW*

50€/jour



BEAM 7R

*Lyre beam 280W 1 roue de couleur
2 roue de gobo / prism 3 et 12 facettes*

60€/jour





INFINIUM 3300
RGB

100€/jour

CONSOLES

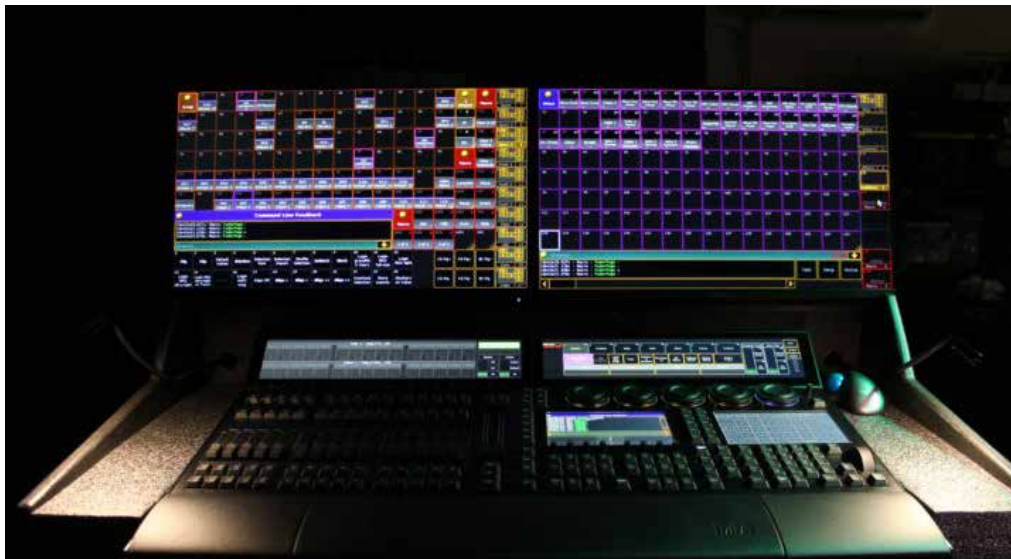

NEW

GRAND MA3 LIGHT

Console asservis
15 faders motorisés, 32 univers

380€/jour

GRAND MA3 COMMAND WING

Console asservis
10 faders motorisés, 8 univers

120€/jour



34



GRAND MA2 FADER WING

*Extension 15 faders
4 univers*

60€/jour



GRAND MA2 COMMAND WING

*Console asservis
5 faders, 2 univers*

70€/jour



2 écrans tactiles

6 univers DMX

1 ordinateur

KIT GRAND MA2 WING + FADER WING

*Consoles asservis 5 faders, 2 univers + extension 15
faders, 4 univers*

200€/jour



35

CONSOLES TRADITIONNELLES



DMX 6
Console DMX
6 canaux

15€/jour



DMX 12/24
Console DMX
12 / 24 canaux/chasers

25€/jour



DMX 24/48
Console DMX
24 / 48 canaux/chasers

45€/jour



GRADATEURS



BLOC 2KW
Gradateur 1 x 2 KW

10€/jour



BLOC 4KW
Gradateur 4 x 1 KW

20€/jour



BLOC 18KW
Gradateur 6 x 3 KW

30€/jour



BLOC 36KW
Gradateur 12 x 3 KW

40€/jour

36

NODES



+SWISSON



XND-4R8
Node RJ45 4 univers

47€/jour

ENREGISTREUR DMX

JBSYSTEMS

DMX RECORDER
8 mémoires

35€/jour



SPLITER DMX

eurolite® BriteQ

SPLIT PONT
Splitter DMX / powercon

10€/jour



DMS-26
Splitter/Merger 2 in / 5 out

20€/jour



LIAISONS DMX

+SWISSON



XWL-R-WDMX-5
Emetteur/Récepteur WDMX

70€/jour



AIR BOX
Emetteur/Récepteur DMX

20€/jour

37

**HYBRIDE
TRUE1 DMX 5P**

3m	5€/jour
5m	7€/jour
10m	8€/jour
15m	9€/jour
20m	10€/jour

**HYBRIDE
POWERCON DMX 3P**

1m	3€/jour
2m	3€/jour
3m	4€/jour
5m	6€/jour
10m	7€/jour
15m	8€/jour
20m	9€/jour



KIT 2 FOUETS RJ45/XLR

4 x 3p

4 x 5p

10€/jour

10€/jour

DMX 5P

3m	2€/jour
5m	3€/jour
10m	3€/jour
15m	4€/jour
20m	5€/jour

DMX 3P

3m	1€/jour
5m	2€/jour
10m	2€/jour
15m	3€/jour
20m	4€/jour

**SOCAPEX
6 CIRCUITS 16A**

10m	13€/jour
15m	15€/jour
20m	18€/jour
Fouet 16A	13€/jour
Fouet PC*	15€/jour
Boitier PC*	18€/jour

*PC : PowerCon

38



ARM-DL32
1 x DMS-26 / 1 x BREAK 32
Bloc 6 x 3 KW
Patch POWERCON

90€/jour



ARM-DL63
3 x DMS-26 / 1 x PD-63 / 2 x BREAK 32
Bloc 6 x 3 KW
Patch POWERCON

190€/jour

HORIZODES PHILIPS



HORIZODE LED
50W

15€/jour



HORIZODE LED
150W

20€/jour



SODIUM
400W

15€/jour

The image features a vertical purple-to-white gradient background. In the lower portion, several dark silhouettes of hands are raised, suggesting a crowd or a celebratory event. A dark purple horizontal bar is positioned across the middle, containing the text 'EFFETS SPÉCIAUX' in white, bold, uppercase letters.

EFFETS SPÉCIAUX



Z1200

Machine à fumée 1200W

45€/jour



TOURHAZER II

Machine à brouillard double pompe 1500W

70€/jour



VULCAN PRO

Geyser de fumée RGBW (6m)

50€/jour



CO2 JET 230V

Buse CO2 jet

80€/jour





ATMOSPHERE
Générateur de brume
Avec apport de CO2

130€/jour



NEW

ME1
Générateur de brouillard
Avec apport de CO2

110€/jour

MACHINE A ÉTINCELLE

SPARKULAR



SPARKULAR BIG
Machine à étincelles froides (6m)

100€/jour



X2 230V
Machine à flamme
Effet 6m droit

180€/jour



GX2 WAVE FLAME
Machine à flamme
Effet 6m motorisé

175€/jour



**Consommables en stock
sur demande**



POWERSHOOT II
Lanceur de canon à confettis

25€/jour



CANON A CONFETTIS

Manuel

Electrique

**Tarif
sur demande**



RED BUTTON
*Bouton de déclenchement
pour effets spéciaux*

10€/jour



Tx2-70k

*Télécommande tir pyrotechnique hf
Commande de flamme (portée 1km)*

135€/jour



Rx2-70k

*Boitier de raccordement
70 lignes hf*

130€/jour



Rx2-30k

*Boitier de raccordement
30 lignes hf*

80€/jour



18r2-hf

*Télécommande tir pyrotechnique hf
(portée 300m)*

40€/jour



BORNIER 72m-hf

*Boitier de raccordement
30 lignes hf*

70€/jour



MAF 60 II

*Système de tir
120 lignes / 5 boitiers*

85€/jour

Pyro de scène sur demande

45

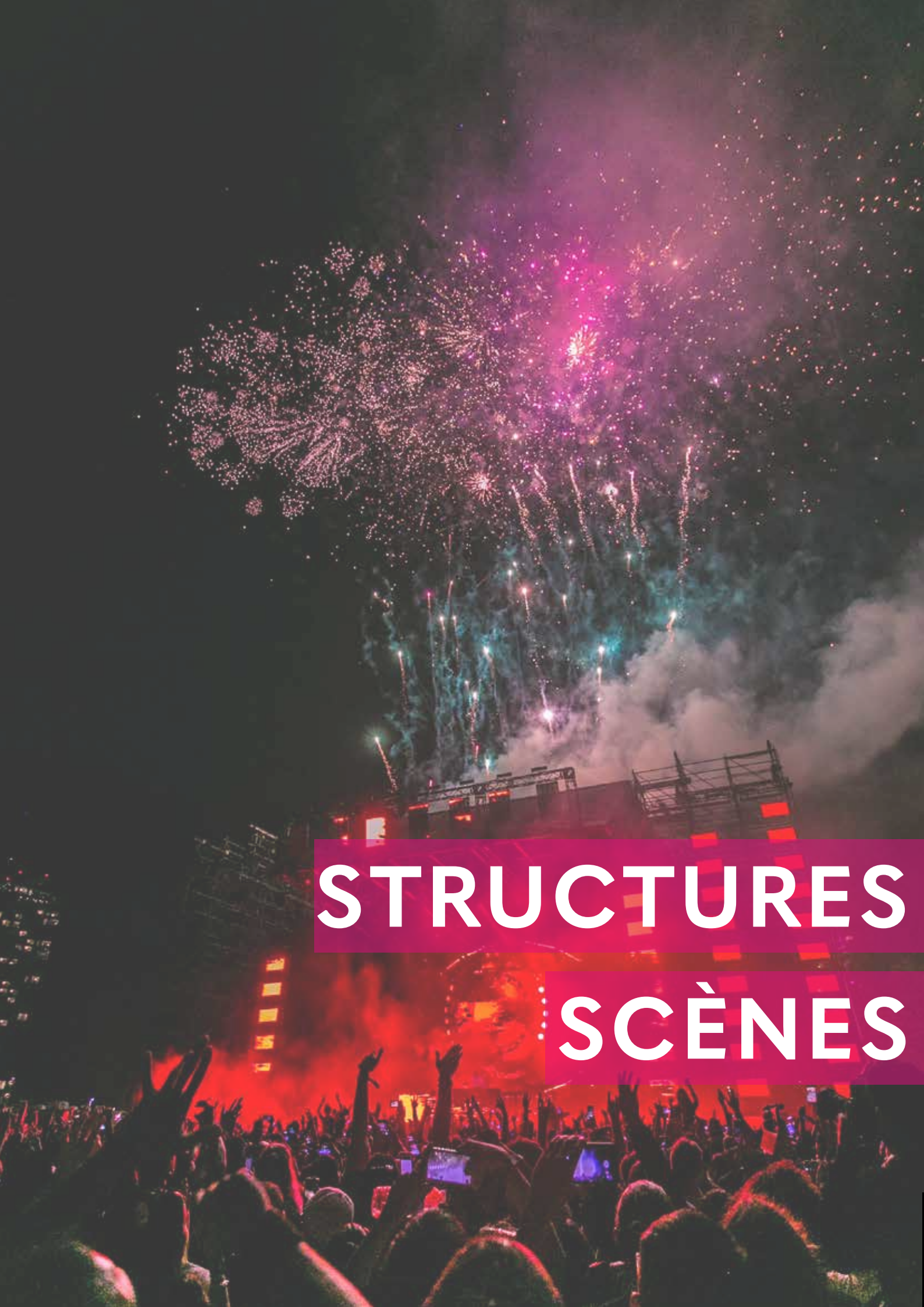

STRUCTURES

SCÈNES

STRUCTURES



MONOTUBE EX50 (ALU)

1m	1€/jour
1.50m	2€/jour
2m	2€/jour
2.50m	3€/jour

MONOTUBE EX50 (NOIR)

0.50m	1€/jour
1m	2€/jour
1.50m	3€/jour
2m	4€/jour
2.50m	5€/jour
3m	6€/jour



COLLIER MANCHON 35mm, 50kg

2€/jour



CERCLE TUBE 2m

10€/jour



BARRE TCAN 0.50m

10€/jour

47



0.50m	2€/jour
1m	3€/jour
2m	5€/jour

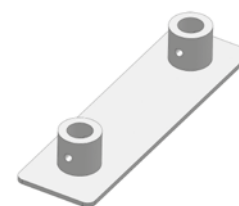
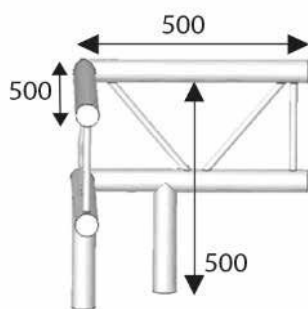
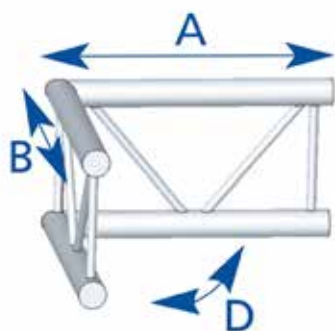

ANGLE 2D

5€/jour

ANGLE 3D

6€/jour

EMBASE EMX290

4€/jour





0.29m	4€/jour
0.50m	5€/jour
1m	6€/jour
2m	11€/jour
3m	16€/jour



ANGLE 2D

10€/jour



ANGLE 3D PIED DROIT

20€/jour

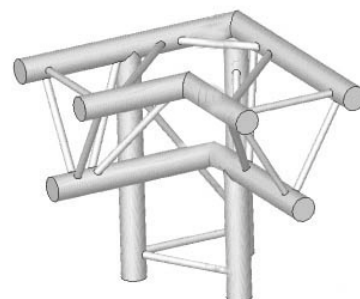

ANGLE 3D PIED GAUCHE

20€/jour

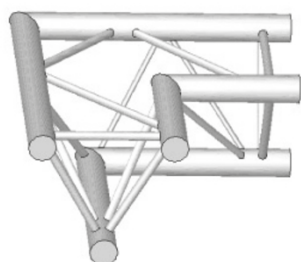

ANGLE 2D

10€/jour

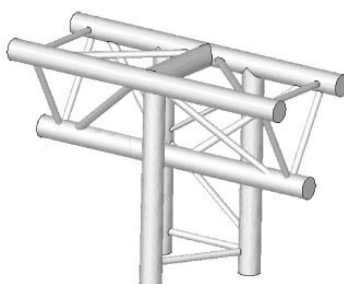

ANGLE 3D PIED T

25€/jour



PIED MAGIQUE

20€/jour

SC300 (ALU)



1m 6€/jour

2m 10€/jour

1.50m 8€/jour

3m 15€/jour

500T (ALU)

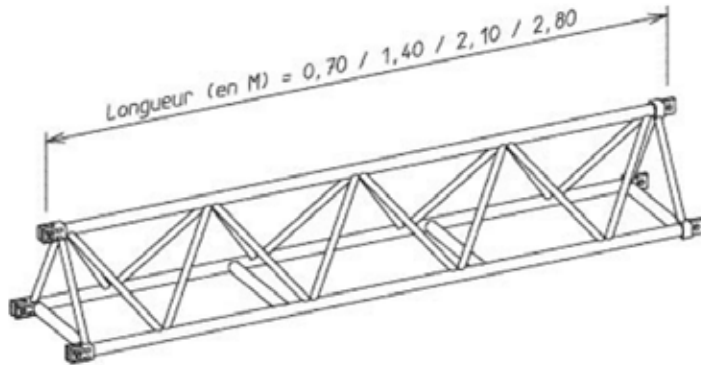

1.40m 10€/jour

2.80m ouvert 18€/jour

2.80m fermé 18€/jour

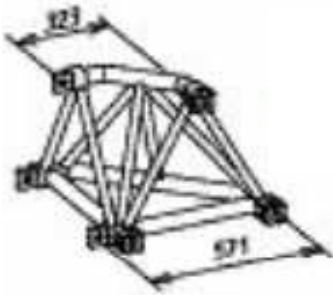

ANGLE 2D

20€/jour

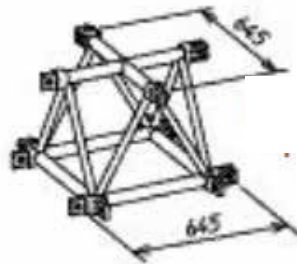

ANGLE 4D

30€/jour



ANGLE LINÉAIRE

15€/jour



ANGLE 4D TIRAGE CENTRAL

50€/jour



50

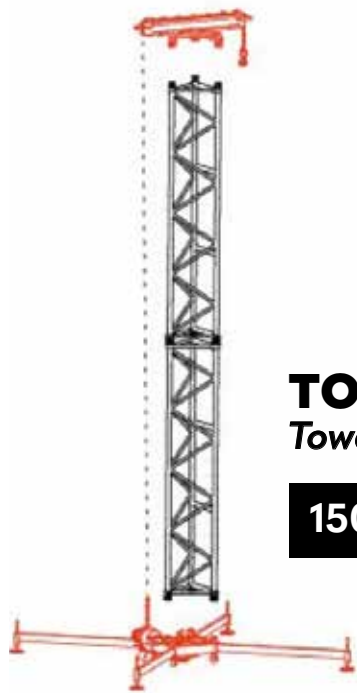

TOWER 1T

Tower avec moteur - H 9m

150€/jour

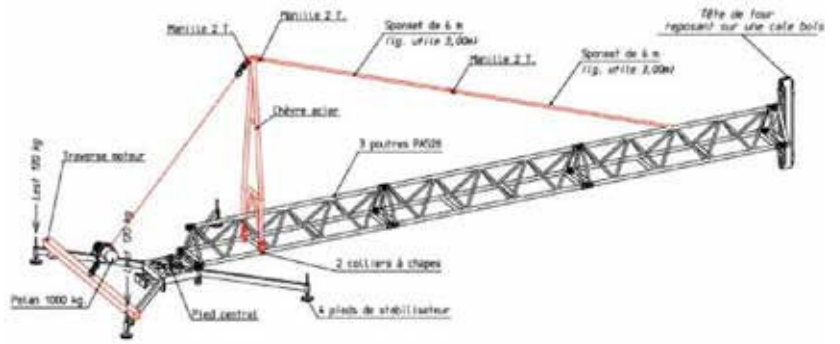

CHÈVRE DE LEVAGE

Montage tower avec palan

100€/jour

PRATICABLES



PRATICABLE PIED FIXE



1 x 1m 10€/jour

2 x 1m 20€/jour

2 x 0.5m 10€/jour

PIED FIXE (LOT DE 4)

0.20m 2€/jour

0.40m 3€/jour

0.60m 4€/jour

0.80m 5€/jour

1m 6€/jour



PIED REGLABLE (LOT DE 4)

0.40 / 0.60m 4€/jour

0.60 / 1m 6€/jour

1 / 1.20m 8€/jour

51



ROULETTE Simple

5€/jour



ROULETTE Double

7€/jour



ESCALIER 0.40/0.60m

45€/jour



ESCALIER 0.80/1.40m

80€/jour

SCÈNE TRADITIONNELLE STACCO

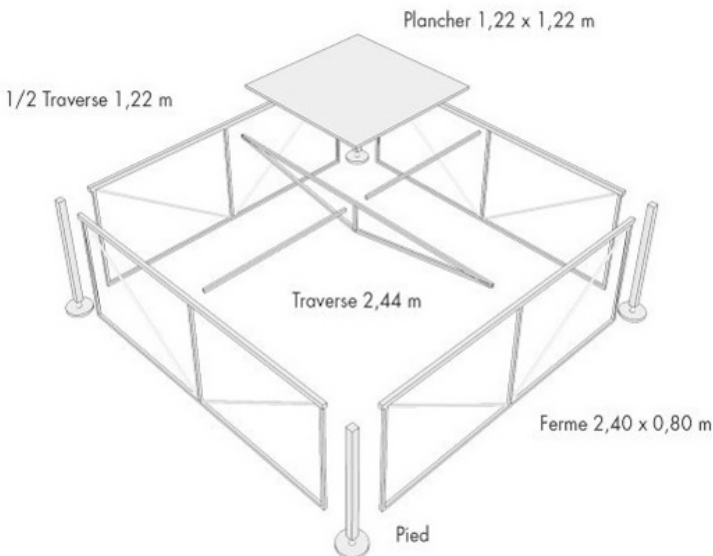

SCENE TRADITIONNELLE H1,20 à 1,90m

Plancher modulaire 2.44 x 2.44m
2.44 x 1.22m / 1.22 x 1.22m

Sur devis



ELV 400 PRO

Pied de levage lumière ou son 4m, 80kg

- Pied à treuil auto-freiné à 3 sections

25€/jour

TE071

Pied de levage 5.40m, 220kg

45€/jour



ST20

Pied de levage à fourche 6.50m, 360kg

55€/jour



ST25

Pied de levage à fourche 8m, 290kg

65€/jour

LEVAGE



PALAN A CHAINE

15m, 1000kg

25€/jour



PALAN A CHAINE

5m, 500kg

10€/jour

ACCESSOIRES



EMBASES



EM259
Embase légère

5€/jour

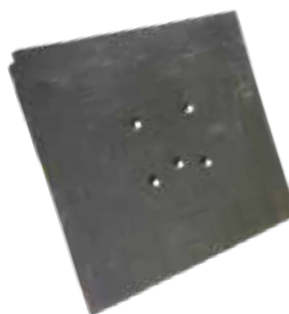

W100
Embase lourde
1 x 1m, 100kg

35€/jour



W40
Embase semi-lourde
0.40 x 0.40m, 40kg

25€/jour



EML259
Diam 1m, 80kg

35€/jour

54



ELINGUES



750kg

1m	1€/jour
1.50m	1€/jour
2m	2€/jour
3m	2€/jour

1T

0.50m	1€/jour
1m	1€/jour
5m	3€/jour
10m	5€/jour

STEEL-FLEX 1T

0.50m	1€/jour
1m	1€/jour
1.50m	1.50€/jour
2m	2€/jour

1.5T

1m	2€/jour
1.50m	2€/jour



MANILLES



1T	1€/jour
2T	2€/jour
3.25T	3€/jour

CROCHETS



COLLIER AVEC ANNEAU

50mm, 200kg

2€/jour



CROCHET ECO

50mm, 200kg

1€/jour



COLLIER SIMPLE

50mm, 75kg

2€/jour



COLLIER DOUBLE

50mm, 75kg

1€/jour



COLLIER SIMPLE

50mm, 500kg

2€/jour



COLLIER DOUBLE

50mm, 500kg

3€/jour



CROCHET «SELFLOCK»

50mm, 250kg

2€/jour



CROCHET «TRIGGER»

50mm, 250kg

2€/jour



PENDRILLON

1 x 7m	5€/jour
--------	---------

3 x 4m	10€/jour
--------	----------

3 x 7m	20€/jour
--------	----------



ECHAFAUDAGE

3 niveaux
Hauteur travail : 2m à 7m

Base	60€/jour
------	----------

+2m	30€/jour
-----	----------



SCENES

LES PRIX NE COMPRENNENT PAS LE MONTAGE

STAGECAR III

EUROPODIUM®
CONCEPTEUR & FABRICANT

SCENE MOBILE 48m²

Clearance 3 ou 4m

1 390€/jour

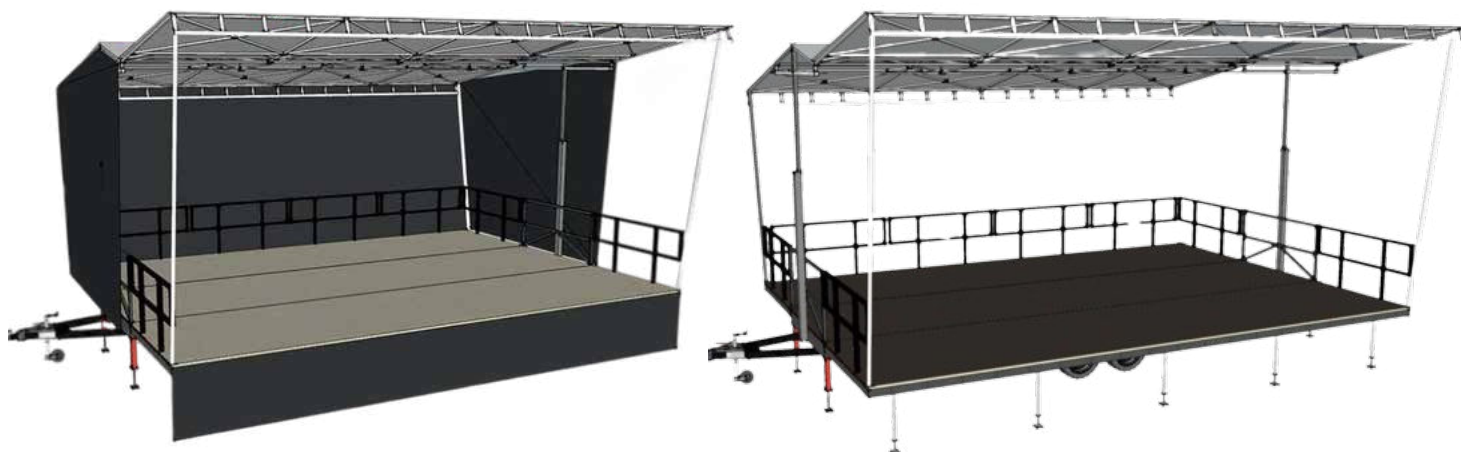

58

OPUS 4200



SCENE MOBILE 55m²
Clearance 4.20m hydraulique

1 690€/jour



59

STAGE 80M2



SCENE TRADITIONNELLE 80m² SUR MAT

Clearance 7.50m

3 780€/jour



STAGE 120M2



SCENE TRADITIONNELLE 120m² SUR MAT

Clearance 7.50m

5 500€/jour



60



VIDÉO



**ÉCRAN 75"
VESTEL**

400€/jour

**ÉCRAN 55"
SAMSUNG**

200€/jour

**ÉCRAN 50"
SAMSUNG**

150€/jour

**ÉCRAN 46"
SAMSUNG**

150€/jour

ACCROCHES



SUPPORT TV

Barre d'accroche murale

10€/jour

PIED TV NOIR

H 1.80m

65€/jour



IPAD-PDS

*Support pour tablette
H 0.63 / 1.08m*

60€/jour



SURFACE 3 BF

*Dalle LED
Pitch 3,9mm indoor
Taille 0.50 x 1m
BLACKFACE*

120€/jour



PROCESSEUR VIDÉO

*Processeur sx 1000 mk2
pc portable + switch HDMI*

150€/jour

ECRANS SUR CADRE

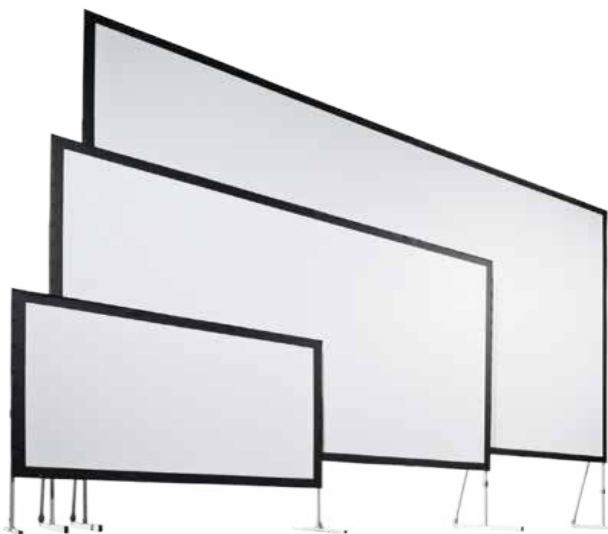

ECRAN SUR CADRE (16/9)

3.70 x 2.10m 110€/jour

4.45 x 2.50m 130€/jour

6.30 x 3.60m 450€/jour

VIDEO PROJECTEURS

Panasonic **EIKI** MITSUBISHI



XD 600
4 500 lumens (XGA)

180€/jour



PTEZ 570
5 500 lumens (FULL HD)

375€/jour



PTRZ 990
10 000 lumens laser (FULL HD)

1100€/jour



XT5
15 000 lumens (XGA)

850€/jour

Focales sur demande

CAMERAS

datavideo



PTC 140
Caméra robot zoom 20x
HDMI / SDI (FULL HD)

200€/jour



PTC 150
Caméra robot zoom 30x
HDMI / SDI (FULL HD)

250€/jour



RMC 180
Pupitre de commande
pour caméra robot

95€/jour

64



ATEM MINI
Mélangeur vidéo HDMI

35€/jour



ATEM TV
Mélangeur vidéo SDI / HDMI

80€/jour

Convertisseurs vidéos sur demande

ENREGISTREMENT



ATOMOS NINJA 2
Enregistreur sur disque SSD

40€/jour



STREAM DECK
15 touches Windows / Mac

15€/jour

SERVEURS VIDEO



BRIGHTSIGN XD234
Lecteur multimédia

55€/jour

ARKAOS
15 / 16Go DDR4
carte vidéo GeForce GTX 1660
SSD NVMA / Livré avec licence

250€/jour



65



VILTROX
L132T - 3300K / 5600K
batterie + chargeur inclus

10€/jour

IANIRO
Mandarine - 800W

20€/jour



NEEWER
NL1320 - 52W 3200K / 5600K

25€/jour

MULTIMEDIA



HP PRO BOOK
i3 / SSD 512Go / Mem 16Go

50€/jour



DELL LATITUDE E7270
i5 / SSD 256Go / Mem 16Go
écran FULL HD

60€/jour



IPAD 4
Couleur blanc

60€/jour

CABLAGE

SDI

0.50m	2€/jour
1m	2€/jour
2m	3€/jour
3m	3€/jour
5m	5€/jour
10m	5€/jour
15m	7€/jour
20m	7€/jour
25m	9€/jour
30m	9€/jour
50m	15€/jour
100m	20€/jour



Livré sur enrouleur

RJ-45

0.50m	1€/jour
1m	2€/jour
2m	3€/jour
5m	5€/jour
10m	10€/jour
15m	12€/jour
30m	20€/jour
50m	30€/jour
75m	40€/jour
100m	50€/jour



Livré sur enrouleur

HDMI FIBRE

50m	20€/jour
75m	30€/jour



Livré sur enrouleur

HDMI

1m	1€/jour	10m	3€/jour
2m	2€/jour	15m	4€/jour
3m	2€/jour	20m	4€/jour
5m	3€/jour	25m	5€/jour

67

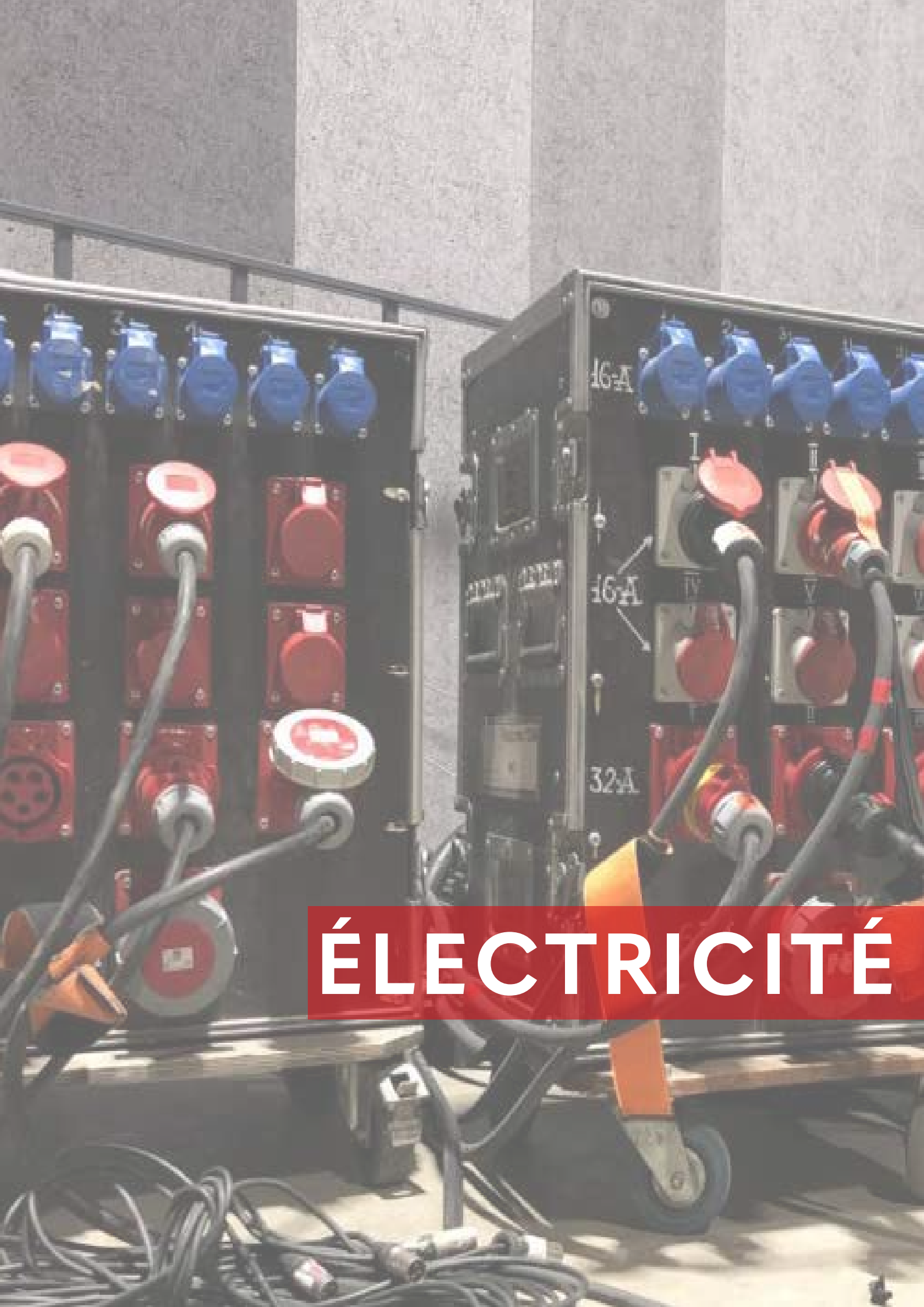

ÉLECTRICITÉ

PROLONGATEUR 16A MONO

1m	1€/jour
2m	1€/jour
3m	1€/jour
5m	2€/jour
6m	2€/jour
10m	3€/jour
15m	3€/jour
20m	4€/jour
25m	4€/jour
40m	5€/jour



Livré
sur enrouleur



TRIPLETTE 32A TETRA

5€/jour

PROLONGATEUR 32A MONO

5m	2€/jour
10m	3€/jour
20m	5€/jour

PROLONGATEUR 32A TETRA

5m	2€/jour
10m	3€/jour
25m	8€/jour

PROLONGATEUR 63A TETRA

5m	4€/jour
10m	6€/jour
20m	17€/jour

PROLONGATEUR 125A TETRA

15m	15€/jour
20m	20€/jour

BOITIER 32-M	ENTRÉE		SORTIE	
	<i>Connexion</i>	<i>Protection</i>	<i>Connexion</i>	<i>Protection</i>
 <p>20€/jour</p>	P17 32A mono	-	2 x 16A	Disjoncteur 16A

ARM 32-M	ENTRÉE		SORTIE	
	<i>Connexion</i>	<i>Protection</i>	<i>Connexion</i>	<i>Protection</i>
 <p>25€/jour</p>	P17 32A mono	-	12 x 16A Direct out 32A mono	Disjoncteur différentiel 16A

ARM 32T/32M-D	ENTRÉE		SORTIE	
	<i>Connexion</i>	<i>Protection</i>	<i>Connexion</i>	<i>Protection</i>
 <p>30€/jour</p>	P17 32A tetra	Disjoncteur différentiel tetra 32A Contacteur d'arrêt d'urgence	3 x P17 32A mono	Disjoncteur mono 32A

BOITIER 32T/16T	ENTRÉE		SORTIE	
	<i>Connexion</i>	<i>Protection</i>	<i>Connexion</i>	<i>Protection</i>
 <p>25€/jour</p>	P17 32A tetra	-	P17 16A tetra	Disjoncteur tetra 16A

BOITIER 32TD	ENTRÉE		SORTIE	
	<i>Connexion</i>	<i>Protection</i>	<i>Connexion</i>	<i>Protection</i>
 <p>25€/jour</p>	P17 32A tetra	-	3 x 16A	Disjoncteur différentiel tetra 20A

CH 32-TD	ENTRÉE		SORTIE	
	<i>Connexion</i>	<i>Protection</i>	<i>Connexion</i>	<i>Protection</i>
 <p>40€/jour</p>	P17 32 tetra	Disjoncteur différentiel tetra 32A	4 x 16A P17 2 x 32A mono	Disjoncteur 16A Disjoncteur 32A

BREAK-32	ENTRÉE		SORTIE	
	<i>Connexion</i>	<i>Protection</i>	<i>Connexion</i>	<i>Protection</i>
 <p>40€/jour</p>	P17 32A tetra	Disjoncteur différentiel tetra 32A	6 x 16A Direct out P17 32 tetra	Disjoncteur 16A

ARM 32T	ENTRÉE		SORTIE	
	<i>Connexion</i>	<i>Protection</i>	<i>Connexion</i>	<i>Protection</i>
 <p>35€/jour</p>	P17 32A tetra	-	12 x 16A Direct out P17 32A tetra	Disjoncteur 16A

ARM 32T-D	ENTRÉE		SORTIE	
	<i>Connexion</i>	<i>Protection</i>	<i>Connexion</i>	<i>Protection</i>
 <p>40€/jour</p>	P17 32A tetra	Disjoncteur différentiel 32A	6x16A 1 x P17 32A tetra	Disjoncteur 16A Disjoncteur différentiel 32A

ARM 63T/32T-D	ENTRÉE		SORTIE	
	<i>Connexion</i>	<i>Protection</i>	<i>Connexion</i>	<i>Protection</i>
 60€/jour	P17 63A tetra	Disjoncteur différentiel tetra 63A	4 x P17 32A tetra	Disjoncteur tetra 32A
		Contacteur d'arrêt d'urgence		

BOITIER 63T/32T	ENTRÉE		SORTIE	
	<i>Connexion</i>	<i>Protection</i>	<i>Connexion</i>	<i>Protection</i>
 40€/jour	P17 63 tetra	-	2 x P17 32 tetra	Disjoncteur tetra 32A

PD-63A	ENTRÉE		SORTIE	
	<i>Connexion</i>	<i>Protection</i>	<i>Connexion</i>	<i>Protection</i>
 45€/jour	P17 63A tetra	Disjoncteur différentiel tetra 63A	2 x P17 32A tetra	Disjoncteur 32A
			3 x 16A	Disjoncteur 16A

ARM 63T-D	ENTRÉE		SORTIE	
	<i>Connexion</i>	<i>Protection</i>	<i>Connexion</i>	<i>Protection</i>
 100€/jour	P17 63A tetra	Disjoncteur différentiel 63A tetra	2 x P17 32A tetra	Disjoncteur 32A tetra
		Contacteur fil pilote	2 x P17 32A mono	Disjoncteur différentiel 32A
		Contacteur d'arrêt d'urgence	4 x P17 16A mono	Disjoncteur différentiel 16A
		Centrale de mesure		

ARM 125T-D	ENTRÉE		SORTIE	
	<i>Connexion</i>	<i>Protection</i>	<i>Connexion</i>	<i>Protection</i>
 90€/jour	P17 125A tetra	Disjoncteur différentiel 125A tetra	2 x P17 63A tetra	Disjoncteur 63A tetra
		Contacteur fil pilote	4 x P17 32A tetra	Contacteur fil pilote
		Arrêt d'urgence	6 x 16A	Disjoncteur 32A tetra
				Disjoncteur 16A

ACCESSOIRES



TRAVCAB

Goulotte de plancher (1 et 2m)

7€/jour



PASCAB

Passage de câble - 2 canaux (1m)

10€/jour

SÉCURITÉ



BLOC DE SECOURS

BAES standard

10€/jour



PR-1106

Preamplificateur 6 entrées
carte «message d'évacuation» AZ1253

50€/jour



NAVIS Y211

Anémomètre avec alarme

40€/jour

75

The background of the image is a dark, almost black, space filled with numerous out-of-focus light spots, known as bokeh. These spots vary in size and color, including warm tones like yellow, orange, and pink, as well as cooler tones like light blue and pale green. The spots are scattered across the frame, creating a soft, dreamy atmosphere. A semi-transparent purple horizontal bar is positioned in the lower-middle section of the image, serving as a backdrop for the text.

DÉCORATIONS



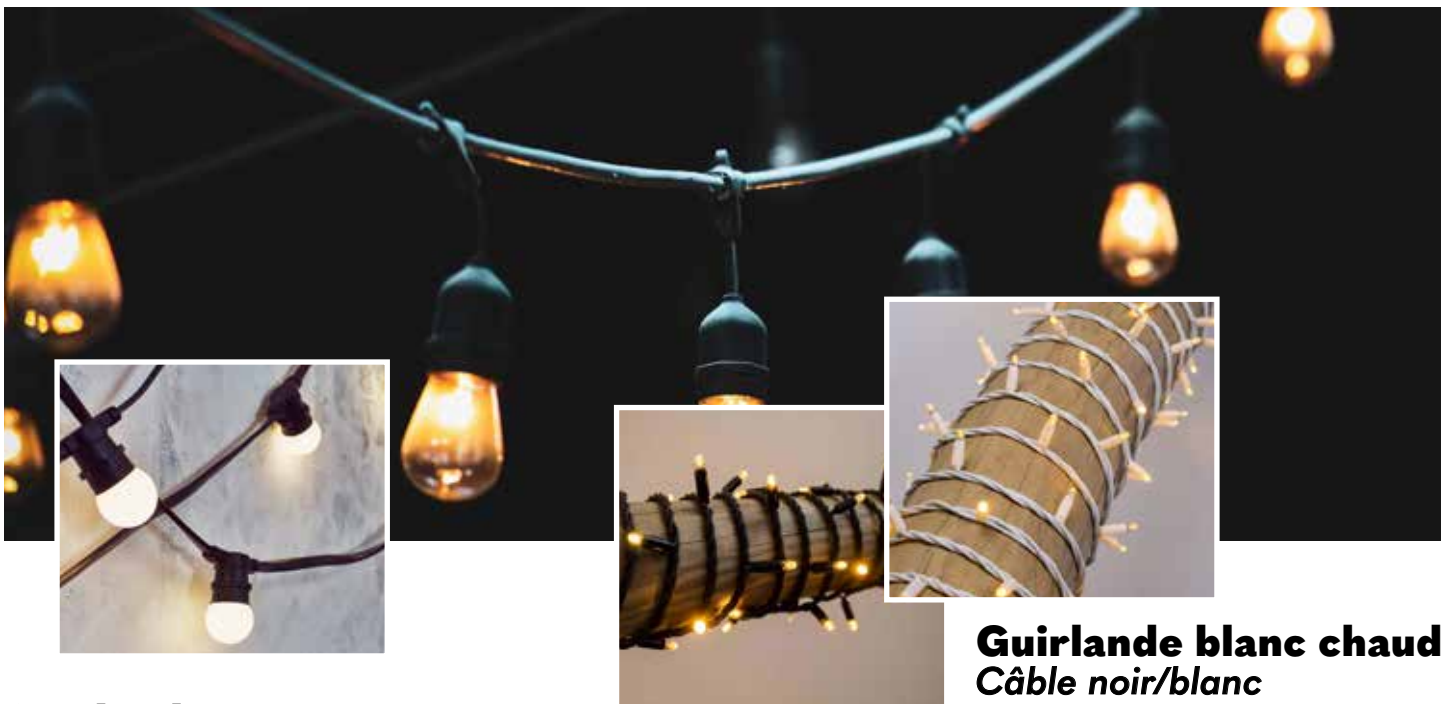

Guirlande guinguette
Câble noir

1€ le mètre/jour

Guirlande blanc chaud
Câble noir/blanc

0.80€ le mètre/jour

Autres guirlandes ou rideaux lumineux sur demande

LETTRES LUMINEUSES



60€/jour

BOULES A FACETTES



30cm

5€/jour

50cm

10€/jour

1m

80€/jour

40cm

7€/jour

80cm

40€/jour

POTELET



POTEAU DE GUIDAGE
H 90cm / L 2m - Plastique noir

20€/jour

79



30€/jour



**POSSIBILITÉ
D'AJOUTER DES
ÉTAGÈRES**

80



BORNES PHOTOS

Selfizee™

BORNE CLASSIK



- Ecran king size 20 pouces
- Imprimante intégrée DNP
- Réflexe canon EOS
- Eclairage LED puissant
- Processeur dernière génération

450€/jour



Intégralement personnalisable



82

BORNE SPHERIK

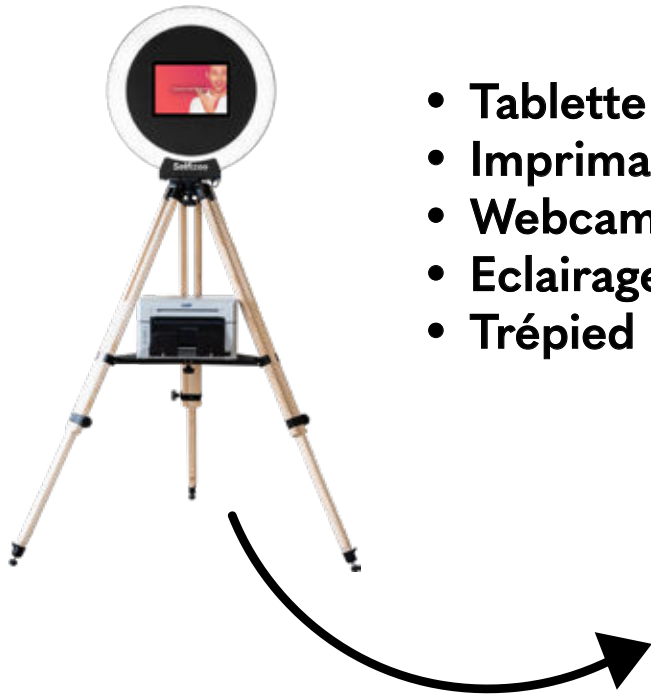

- Tablette windows surface 10 pouces
- Imprimante professionnelle DNP
- Webcam HD 4K
- Eclairage LED puissant
- Trépied en bois renforcé

390€/jour



Faces avant/arrière personnalisables



83

BORNE PRESTIGE



- Tablette windows surface 10 pouces
- Imprimante professionnelle DNP
- Webcam HD 4K
- Eclairage LED puissant
- Pied droit métallique

450€/jour



Faces avant/arrière personnalisables



84

1. RÉSERVATIONS

1-1 Toute réservation implique l'adhésion sans réserve à nos conditions générales de location quelques soient les clauses figurant au sein des bons de commande des clients.

1-2 Toutes les réservations doivent faire l'objet d'un écrit, courrier ou fax, de la part du client au moins 24h00 à l'avance et ne sont acceptables que dans la limite des stocks disponibles.

Le matériel faisant l'objet d'une réservation acceptée demeure disponible 24h00 maximum après la date de départ prévue.

1-3 Dans le cadre d'une annulation de réservation, tous les acomptes déjà versés restent acquis à WTECH GROUP à titre de dédommagement forfaitaire.

1-4 Le client devra signaler lors de sa réservation si le matériel doit sortir du territoire national.

2. PROPRIÉTÉ

Le matériel est la propriété de WTECH GROUP, à ce titre il est insaisissable par les tiers et le locataire n'a pas le droit de le céder ou de le sous-louer. Il ne doit apporter aucune modification superficielle ou substantielle au matériel.

3. DURÉE DE LA LOCATION

3-1 Le bon de livraison obligatoirement délivré à chaque sortie de matériel indique la date et l'heure du retrait ainsi que la date présumée du retour.

3-2 Seul le retour physique du matériel en nos locaux détermine la durée de location, décomptée en journées de 24h00, dimanche et jours fériés compris, sans tenir compte de l'utilisation ou non du matériel.

4. RETRAIT DU MATÉRIEL

4-1 Le client réceptionne le matériel loué en nos locaux du lundi au vendredi de 09h30 à 12h30 & de 14h00 à 18h00. Éventuellement le samedi de 09h30 à 12h30.

4-2 Le retrait du matériel s'effectue en échange d'un dépôt de garantie (à la discrétion de WTECH GROUP, soit au moins 10 fois le montant de la location d'une journée, soit 2 fois le loyer de la période) accompagné de la totalité du règlement de la location ou d'un bon de commande pour les sociétés ayant un compte ouvert dans nos registres.

4-3 Une quittance PTT ou EDF libellée à l'adresse des chèques sera demandée aux particuliers.

4-4 Le client qui le désire est convié à assister à l'essai du matériel mis en oeuvre systématiquement avant chaque départ. Après essai concluant, le matériel est considéré en parfait état de fonctionnement même si le client n'a pas assisté au test.

5. RESTITUTION DU MATÉRIEL

5-1 Le client est tenu de restituer le matériel loué à la date figurant sur le contrat de location.

5-2 Toute prolongation de location devra être signalée 24h00 avant le retour prévu initialement. Elle ne pourra avoir lieu qu'après l'accord de WTECH GROUP et devra dans tous les cas être confirmée par un nouveau bon de commande. En cas de prolongation, les principes de facturation appliqués à la commande ne seront pas forcément maintenus.

5-3 Toute restitution non justifiée après la date prévue, entraînera la responsabilité du client pour les préjudices subis par la société WTECH GROUP et sa clientèle.

5-4 Tout matériel manquant ou détérioré sera facturé sur la base du tarif " WTECH GROUP " en vigueur valeur neuve. Un délai supplémentaire de 48h00 est admis pour la restitution de petits matériels et accessoires manquants au retour ; passé ce délai, la facturation deviendra définitive. Les lampes restituées hors service seront facturées à 70 % de leur valeur neuve.

6. TARIFS

Les prix facturés sont ceux du tarif en vigueur au jour de la livraison, WTECH GROUP se réservant le droit de modifier ses tarifs à tout moment sans préavis. Le taux de T. V. A. appliqué est de 20% sur l'ensemble des services offerts.

7. CONDITIONS DE RÉGLEMENT

7-1 Un acompte de 30% sera versé à la commande et le solde le jour de la livraison.

7-2 Un chèque de caution peut vous être demandé et sa valeur sera égale à 10 fois le montant de la location.

7-3 WTECH GROUP, sous réserve de l'accord de son service financier, pourra procéder à des ouvertures de compte pour ses clients.

7-4 Conformément à l'article 3 de la loi n°92-1442 du 31 décembre 1992, les prorogations d'échéances entraîneront automatiquement la perception d'agios au taux de 1,5 fois le taux d'intérêt légal.

7-5 Le non-respect par le locataire de l'une quelconque de ces obligations aura pour conséquence :

- l'exigibilité immédiate de toute somme restante due, sans prendre en compte le mode et le terme de paiement initialement prévu.
- le paiement, à titre de clause pénale, en sus d'une indemnité, pour frais de recouvrement de 15 % sur le montant des sommes exigibles sous réserve de tous autres dus.
- l'autorisation pour WTECH GROUP de surseoir à de nouvelles livraisons.

8. RESPONSABILITÉS

8-1 Le locataire en qualité de dépositaire assume l'entière responsabilité du matériel dès sa prise en charge en nos locaux et jusqu'à sa restitution. Il est seul responsable de tous dégâts causés au matériel ou du fait du matériel.

8-2 Le locataire doit se préoccuper d'avoir les autorisations nécessaires pour l'utilisation des émetteurs H.F. audio et vidéo, talkie-walkie, radio, téléphone, etc.

8-3 L'indemnisation du matériel sinistré s'effectue sur la valeur de remplacement à neuf au jour du sinistre, sans application de dépréciation ni remise commerciale suivant le prix de vente public ou sur la base des frais de remise en état au coût du jour.

8-4 Le locataire doit utiliser le matériel conformément à sa destination.

8-5 La responsabilité de WTECH GROUP ne saurait être engagée suite au non-fonctionnement ou mauvais fonctionnement des appareils loués liés à l'adjonction de matériels non compatibles, ou à une mauvaise installation.

9. ASSURANCES

9-1 Le locataire doit assurer le matériel pour sa valeur de remplacement à neuf.

9-2 L'assurance doit notamment couvrir les risques de vol, perte ou détérioration quelle qu'en soit la cause ou la nature.

9-3 Le locataire fait son affaire de tous risques de mise en jeu de sa responsabilité civile, à raison de tout dommage causé par le matériel ou à raison de toute utilisation pendant qu'il est sous sa garde.

10. CLAUSE RESOLUTOIRE

À défaut par le locataire d'exécuter l'une quelconque des conditions générales de location, la résiliation de la location sera encourue de plein droit, 48 heures après une mise en demeure restée infructueuse et sans autre formalité judiciaire. Si le locataire refusait soit de payer soit de restituer le ou les matériels, les sommes versées en dépôt resteraient acquises au loueur, sans préjudice de tous les dommages et intérêts qui pourraient être réclamés par ailleurs.

11. LITIGE

En cas de litige, le Tribunal de commerce de CAEN (14) sera seul compétent.

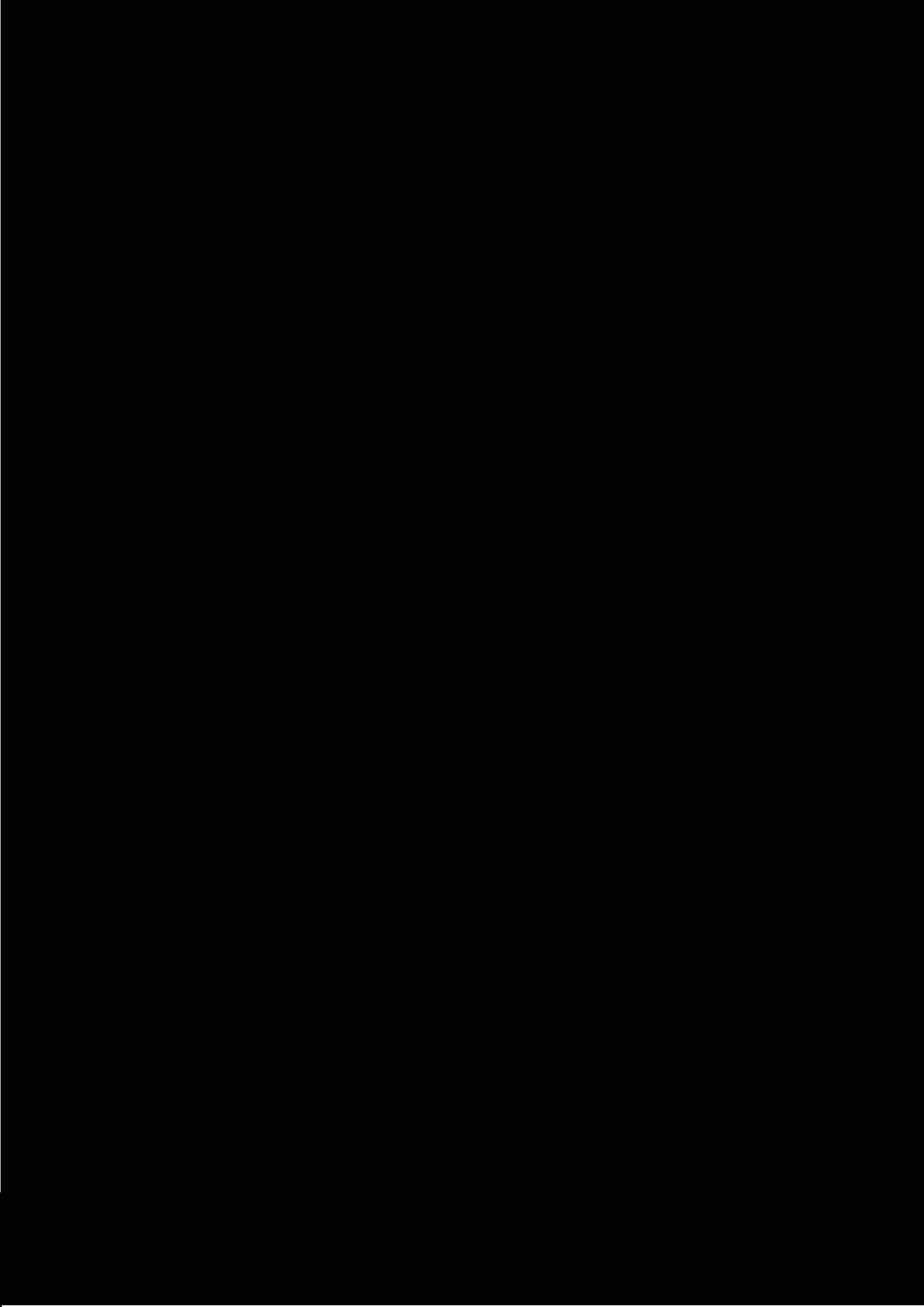

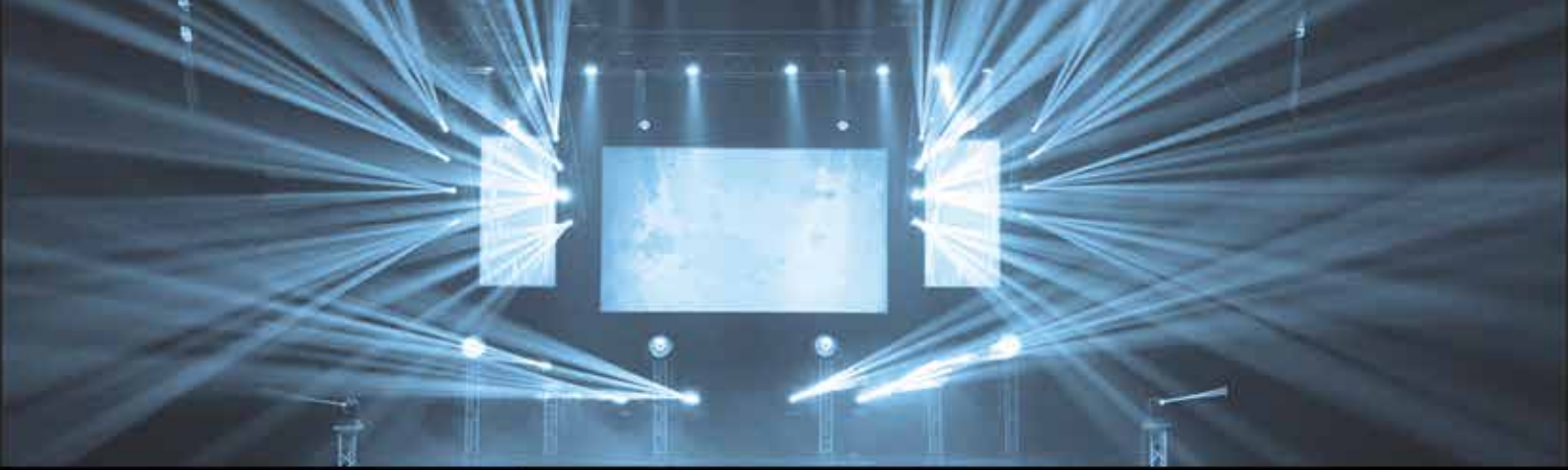

 **WTECH**
group

